



www.drakecorp.com

DRAKE CORP. • 154 Tices Lane • East Brunswick NJ 08816 • Tel. +1 732 254 1530 • Fax +1 732 254 3509 • email: contactUS@drakecorp.com

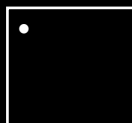
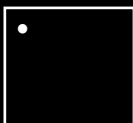
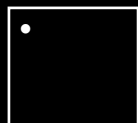
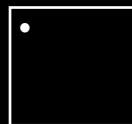
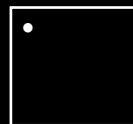
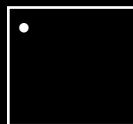
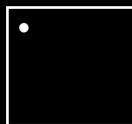
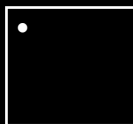
Tre3 tables



TRE3 STACKING BAR TABLE



TRE3 STACKING TABLE



Tre3 tables & bar tables

Designed by up and coming architects and designers L. Nichetto & C. Tinti, the Tre 3 seamlessly integrates classic geometrical styling with new age elegance to create a look that seems to defy gravity. The Tre 3 line sets a new standard for furniture as functional art and its design has no compromise between style and function, beauty and strength.

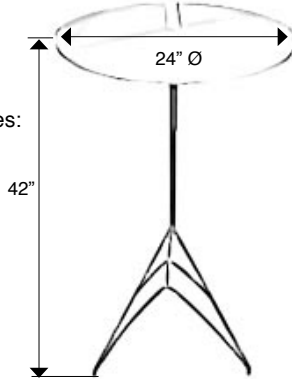
The Tre 3 tables are stackable and there is no folding, disassembling or tricks of any kind to prepare them for storage. The metal frame slides into the opening of the next tabletop while a soft mount stack system protects the tables as they nest into one another.

The minimalist tri support system gives the table its floating look and strength.

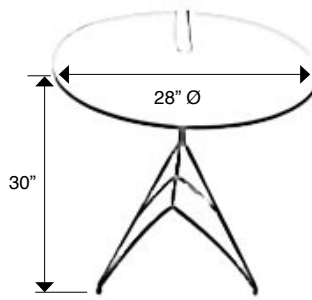


TABLE TOP Made of a composite multilayer Acrylic technopolymer (ABS core and SAN skin) is available in 2 sizes:
24" Ø
28" Ø
color: White

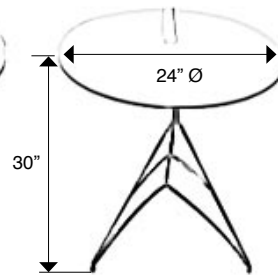
CHROME METAL FRAME is available in 2 different sizes:
30" high (regular tables)
42" high (bar tables)



Tre3 STACKING BAR TABLE
ITEM# 6TR24B
Dimensions: 24"Ø x 42"h
Net weight: 22.5 lb.



Tre3 STACKING TABLE
ITEM# 6TR28
Dimensions: 28"Ø x 30"h
Net weight: 24 lb.



Tre3 STACKING TABLE
ITEM# 6TR24
Dimensions: 24"Ø x 30"h
Net weight: 20.5 lb.

Made in Italy

*simply elegant...
fit anywhere*



08.06

DISTRIBUTED BY: