

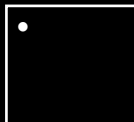

[www.drakecorp.com](http://www.drakecorp.com)

DRAKE CORP. • 154 Tices Lane • East Brunswick NJ 08816 • Tel. +1 732 254 1530 • Fax +1 732 254 3509 • email: [contactUS@drakecorp.com](mailto:contactUS@drakecorp.com)

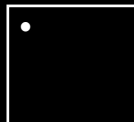
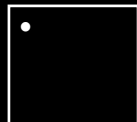
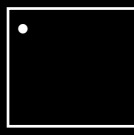
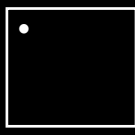

# Tre 3 STACKING CHAIRS AND STOOLS

Designed by up and coming architects and designers L. Nichetto & C. Tinti, the Tre3 seamlessly integrates classic geometrical styling with new age elegance to create a look that seems to defy gravity. The Tre3 line sets a new standard for furniture as functional art and its design has no compromise between style and function, beauty and strength. The Tre3 chairs, stools and tables are stackable and there is no folding, disassembling or tricks of any kind to prepare them for storage simply stack and forget, designed with a special soft mount stack system that actually protects the chairs as they nest into one another. The minimalist tri support system gives both the chair and stool their floating look and strength, while they may look like a delicate piece of art they have been designed and rigorously tested to take the abuses involved with heavy commercial use.

Made of a composite multilayer technopolymer seat and chrome metal legs

Seat Colors:

- W** White
- Y** Pastel Yellow
- L** Lime
- G** Light Gray

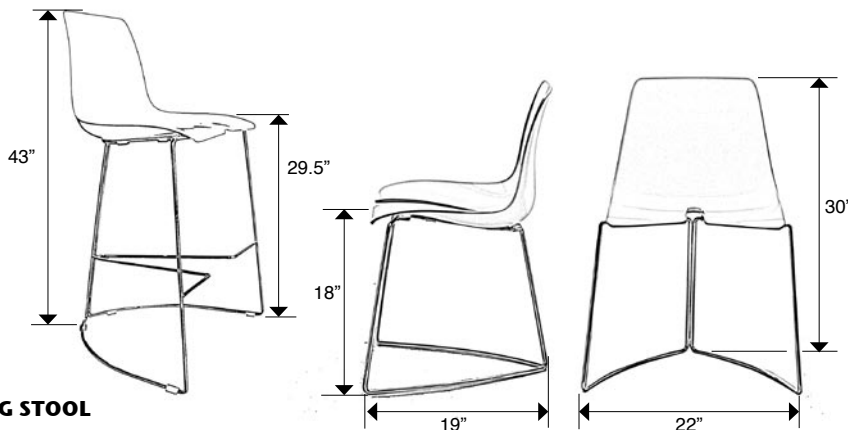

## Tre 3 STACKING STOOL

ITEM# 6tre3S

Seat Dimensions: 17.5"x15"x29.5"h

Weight: 21 lb.

## Tre 3 STACKING CHAIR

ITEM# 6tre3C

Seat Dimensions: 17.5"x15"x18"h

Weight: 15 lb.

# Tre 3 CUOIO

Made in Italy

The CUOIO series adds the magic of leather to the elegant Italian design of the Tre3 collection. It's the luxury finish everyone dreams of...

Handcrafted midgrain leather with 19 colors to chose from. Made to order only.

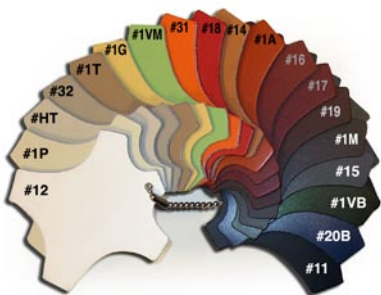

\* Tre3 cuoio series are non-stacking